

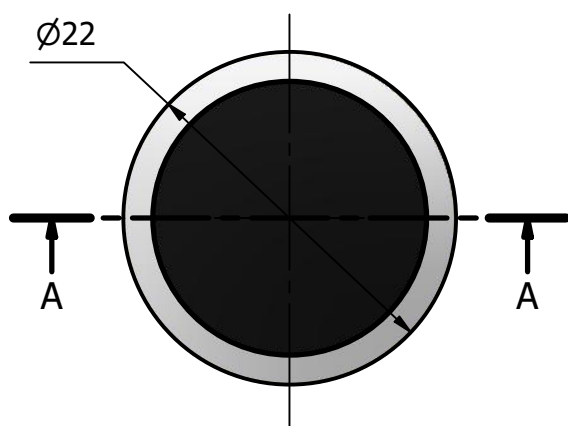

A-A (2:1)

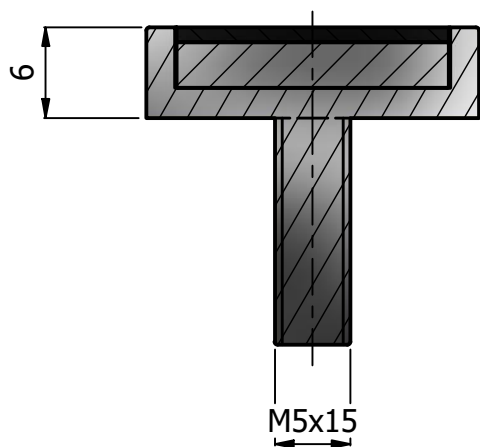

Tutte le misure indicate sono in millimetri (mm).

Disegnato M.D.	Data 22/07/2019	Tipo SM08	Trattamento	Materiale	Tolleranza +/- 0.1 mm
			Descrizione Sistema magnetico in neodimio resinato nero (N + S)		
Via F. Comelli 39 33034 Fagagna UD - Tel. 0432 801675			Codice SM08.35NI00.2265	Scala 2 : 1	Formato A4